



88W8987 (Automotive): 2.4/5 GHz Dual-Band 1x1 Wi-Fi® 5 (802.11ac) + Bluetooth® 5.2 Solution

88W8987A

Last Updated: Apr 9, 2022

The 88W8987 automotive wireless SoC is a highly integrated IEEE 802.11ac (wave2) transceiver and Bluetooth 5.2 single-chip foot print compatible combo solution, specifically designed to support the speed, reliability and quality requirements for automotive applications. Further, this device meets the challenges of high-temp environments by being AEC-Q100 Grade 3 (-40°C to 85°C) qualified. The device includes integrated front end resulting in low external component cost.

88W8987 (automotive) application diagram Block Diagram

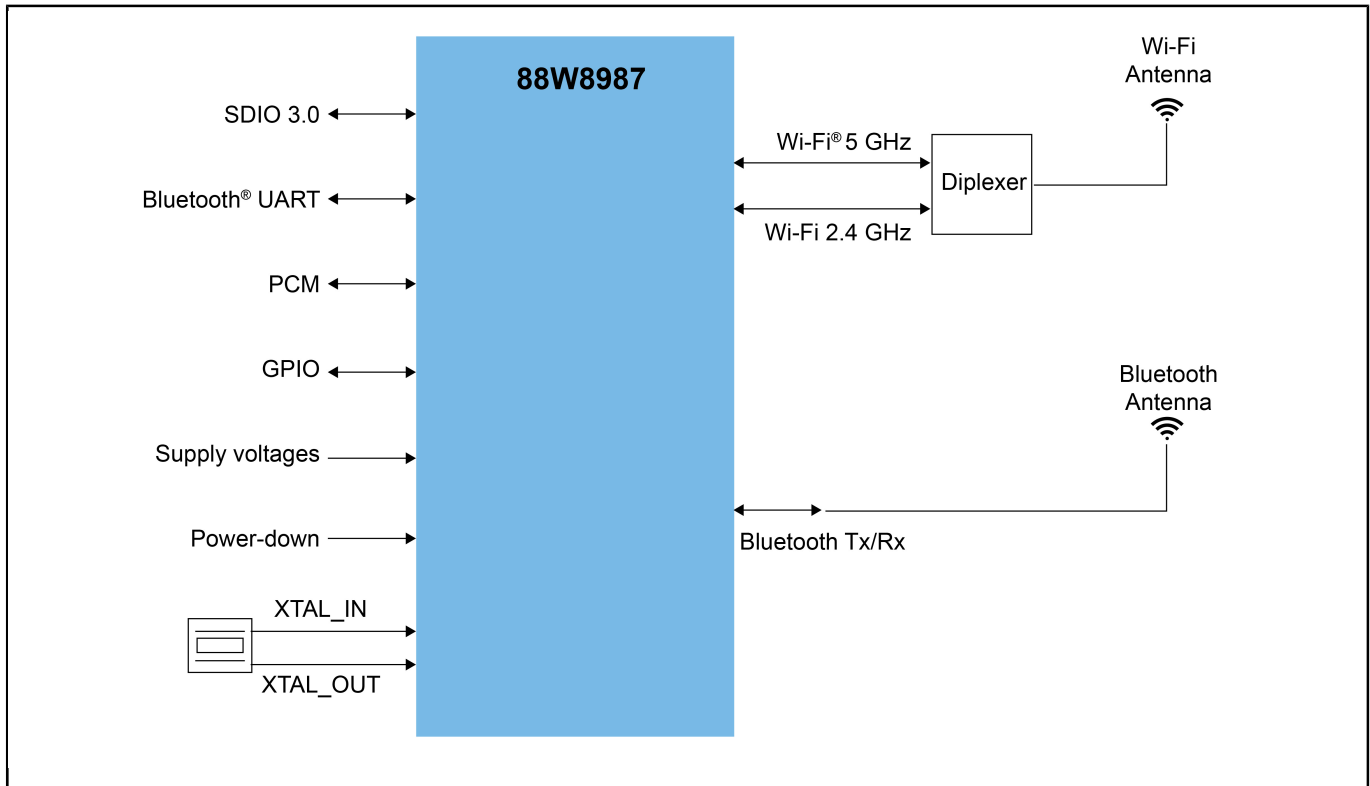

View additional information for [88W8987 \(Automotive\): 2.4/5 GHz Dual-Band 1x1 Wi-Fi® 5 \(802.11ac\) + Bluetooth® 5.2 Solution](#).

Note: The information on this document is subject to change without notice.

www.nxp.com

NXP and the NXP logo are trademarks of NXP B.V. All other product or service names are the property of their respective owners. The related technology may be protected by any or all of patents, copyrights, designs and trade secrets. All rights reserved. © 2022 NXP B.V.