



Audio Video Bridging Software

AVB-SOFTWARE

Last Updated: May 30, 2023

NXP's Audio Video Bridging (AVB) software provides a complete set of AVB protocols for use on several different NXP development boards, reducing the need for hardware changes and eliminating redevelopment costs.

For applications requiring audio, video, and other real time content over Ethernet, NXP's AVB software provides a complete set of AVB protocols enabling transport and sink services to multimedia applications. We offer stack solutions for end-node devices (such as the display and speakers) as well as a fully featured AVB switch.

The AVB standard adds features like time-synchronized low latency streaming services and bandwidth reservation to make it possible to carry audio and video signals on a standard Ethernet line. AVB is able to accomplish this by reserving a fraction of the available Ethernet bandwidth for AVB traffic.

This software product is offered through NXP Professional Services. Please complete and submit this [form](#) and someone from the Services team will be in contact with you.

AVB/TSN software is also available some i.MX RT platforms as part of the MCUXpresso SDK. See [this page](#) for more information.

Audio Video Bridging Software Block Diagram

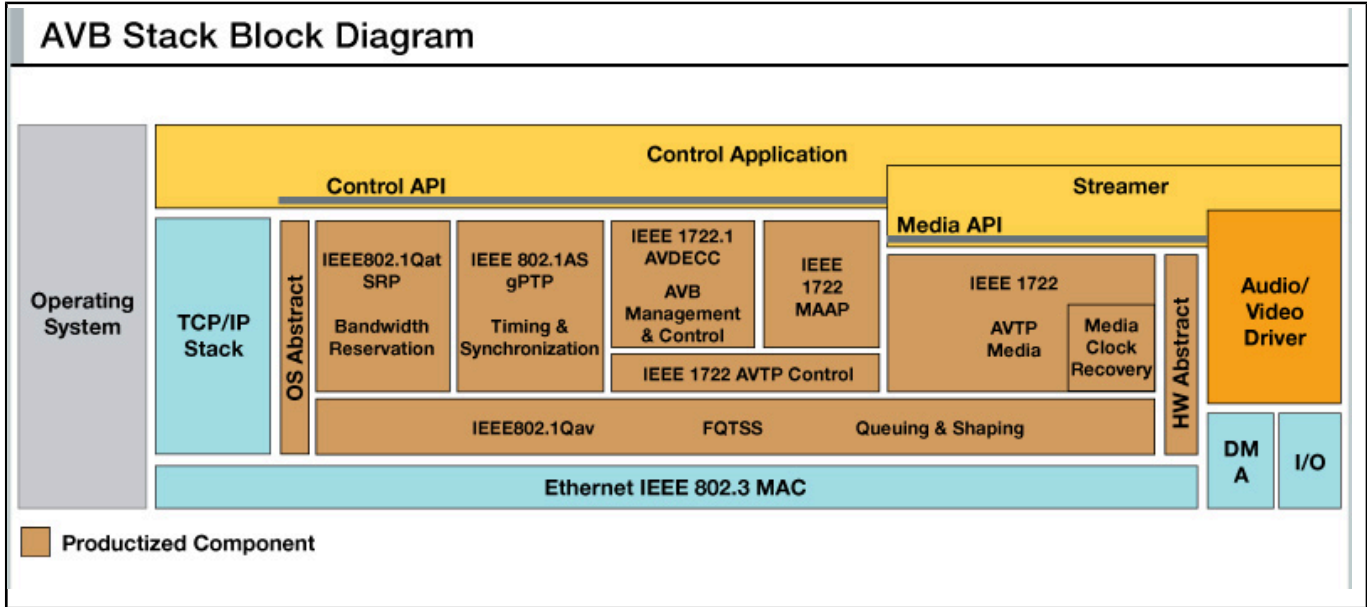

View additional information for [Audio Video Bridging Software](#).

Note: The information on this document is subject to change without notice.

www.nxp.com

NXP and the NXP logo are trademarks of NXP B.V. All other product or service names are the property of their respective owners. The related technology may be protected by any or all of patents, copyrights, designs and trade secrets. All rights reserved. © 2023 NXP B.V.