



Programmable Gate Driver for Solenoid Control

PT2001

Last Updated: Jul 20, 2023

The PT2001 is a programmable gate driver IC for precision solenoid control applications, which makes the component very flexible and relieves the main microcontroller from the intensive task of the actuator control.

The chip integrates four microcores used to control, five external MOSFET high-side pre-drivers, seven external MOSFET low-side pre-drivers, a DC-DC converter, integrated end of injection detection, current measurement and diagnostics.

PT2001: Programmable Gate Driver for Solenoid Control Block Diagram Block Diagram

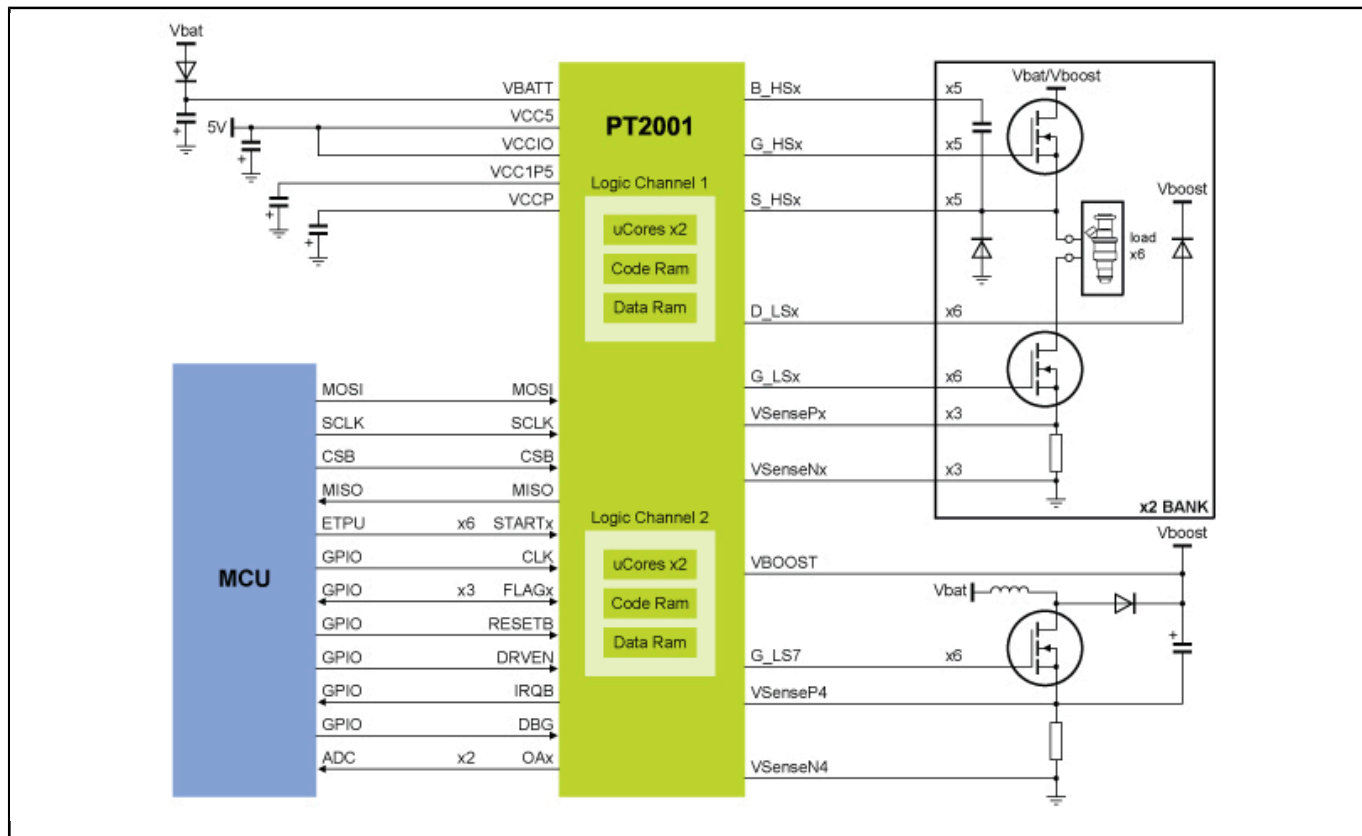

View additional information for [Programmable Gate Driver for Solenoid Control](#).

Note: The information on this document is subject to change without notice.

www.nxp.com

NXP and the NXP logo are trademarks of NXP B.V. All other product or service names are the property of their respective owners. The related technology may be protected by any or all of patents, copyrights, designs and trade secrets. All rights reserved. © 2023 NXP B.V.