



GreenChip Synchronous Rectifier Controller

TEA1999TS

Last Updated: Apr 9, 2022

The TEA1999TS is a member of a new generation of Synchronous Rectifier (SR) controller ICs for switched mode power supplies with adaptive gate drive for maximum efficiency at any load.

The TEA1999TS is a dedicated controller IC for synchronous rectification on the secondary side of flyback converters. It incorporates the sensing stage and driver stage for driving the SR MOSFET, which is rectifying the output of the secondary transformer winding.

The TEA1999TS can generate its own supply voltage for battery charging applications with low output voltage or for applications with high-side rectification.

The TEA1999TS is fabricated in a Silicon-On-Insulator (SOI) process.

TEA1999TS Block diagram Block Diagram

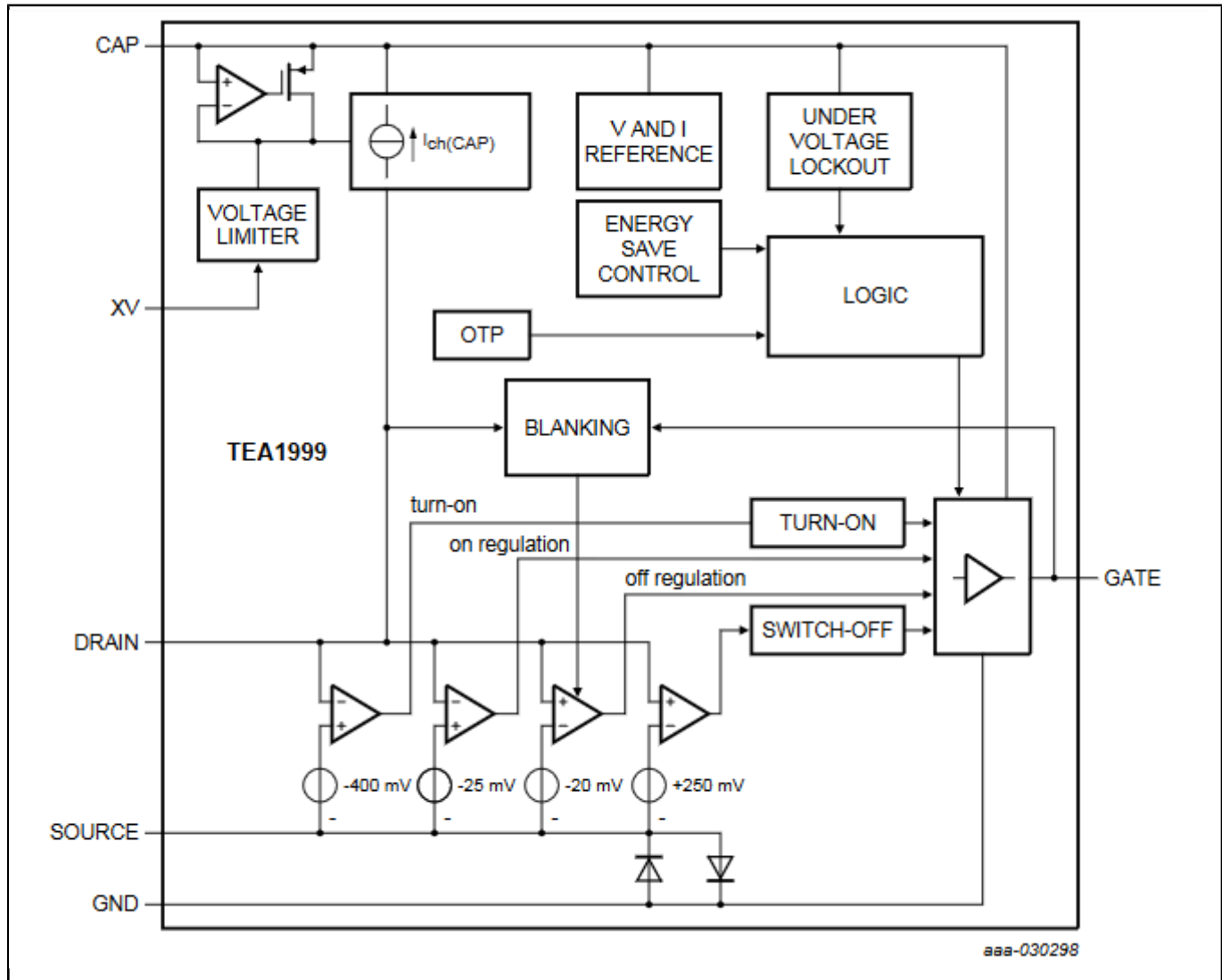

View additional information for [GreenChip Synchronous Rectifier Controller](#).

Note: The information on this document is subject to change without notice.

www.nxp.com

NXP and the NXP logo are trademarks of NXP B.V. All other product or service names are the property of their respective owners. The related technology may be protected by any or all of patents, copyrights, designs and trade secrets. All rights reserved. © 2023 NXP B.V.